

REV		ED	DESCRIPTION	DWN	APPROVED	DATE
F		13357	ADDED -12-01 THRU -17-008, -112-01 THRU -117-008, -812-01 THRU -817-008 AND ITEM 16 TO BOM FOR SST WITH D-LUG B-3265-1 UPGRADE TO LARGER FORMAT, UPGRADE TABLE 1 AND 2; ADDED VIEW FOR SST ROPE & D-LUG; CHANGED NOTE 4; SG ±.03 WAS .500 ±.030; GENERAL UPDATE; SEE ECO	DKC		

SH ID	DESCRIPTION
1	CAP (NO CHAIN)
2	CAP WITH 2.5 BRASS CHAIN
3	CAP WITH 2.5 NYLON CHAIN
4	CAP WITH 3.0 BRASS CHAIN
5	CAP WITH 3.0 NYLON CHAIN
6	CAP WITH 6.0 BRASS CHAIN
7	CAP WITH 6.0 NYLON CHAIN
8	CAP WITH 4.0 BRASS CHAIN
9	CAP WITH 4.0 NYLON CHAIN
10	CAP WITH 10.0 BRASS CHAIN
11	CAP WITH 10.0 NYLON CHAIN
12	CAP WITH 2.5 INCH SST ROPE
13	CAP WITH 3.0 INCH SST ROPE
14	CAP WITH 6.0 INCH SST ROPE
15	CAP WITH 4.0 INCH SST ROPE
16	CAP WITH 7.0 INCH SST ROPE
17	CAP WITH 4.5 INCH SST ROPE

MODEL NO	TYPE
RFI85	2-LUG
RFI853	3-LUG
RFI385	THREAD

DASH NO	"A" DIA	"B" DIA	"C" DIM	"D" DIM
-D1	.755	.875	1.191	.513
-D2	.630	.750	1.066	.450
-D3	.505	.625	.941	.388
-D4	.439	.562	.878	.355
-D5	.380	.500	.816	.325
-D6	.317	.437	.753	.295
-D7	.281	.406	.722	.278
-D8	.610	.750	1.066	.450
-D9	.567	.687	1.003	.419
-DD8	.330	.450	.766	.300
-D10	.192	.312	.628	.231

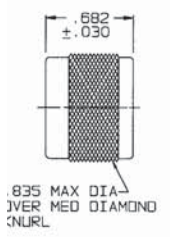

RFI385-1
SHOWN
NO CHAIN/ROPE OR MOUNTING LUG

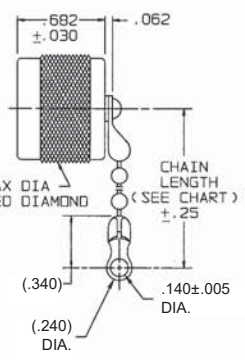

RFI385-2 THRU -10
SHOWN
STANDARD CHAIN & MOUNTING LUG

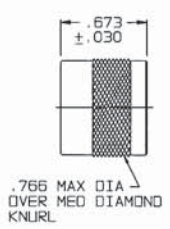

RFI85/RFI853-1
SHOWN
NO CHAIN/ROPE OR MOUNTING LUG

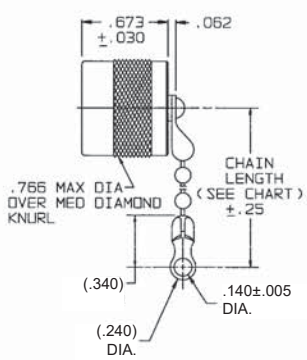

RFI85/RFI853-2 THRU -11
SHOWN
STANDARD CHAIN & MOUNTING LUG

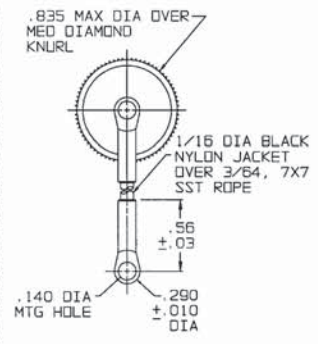

RFI385-12 THRU -17
SHOWN
STAINLESS STEEL ROPE AND MOUNTING LUG

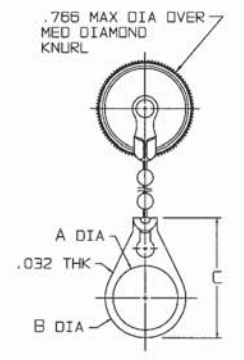

RFI85/RFI853-2-01
THRU -11-008 SHOWN
STANDARD CHAIN AND BULKHEAD JACK MOUNTING LUG

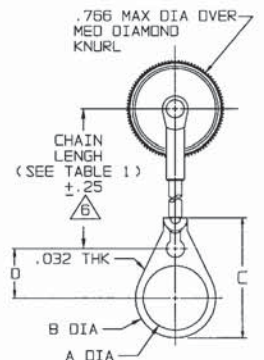

RFI85/RFI853-12-01
THRU -17-008 SHOWN
SST ROPE AND BULKHEAD JACK MOUNTING LUG

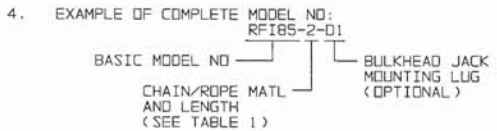

3. MALE "C" STYLE DUST CAP
2. FINISH: NICKEL
1. ALL DIM ARE IN INCHES

QTY	DESCRIPTION	PART NUMBER	ITEM
TOL. UNLESS SPECIFIED - .001 ± - .002 ± - .005 ± - .0002 ± - .0005 ±	TROMPETER ELECTRONICS, INC.	RFI 85/853/385	
DWN CHK ENGR APPV	MATERIAL 14949	CODE IDENT 305-0137	REV F
NEXT ASSY	SCALE 2/1	DATE 11-14-73	SHEET 1C