

RoHS COMPLIANT

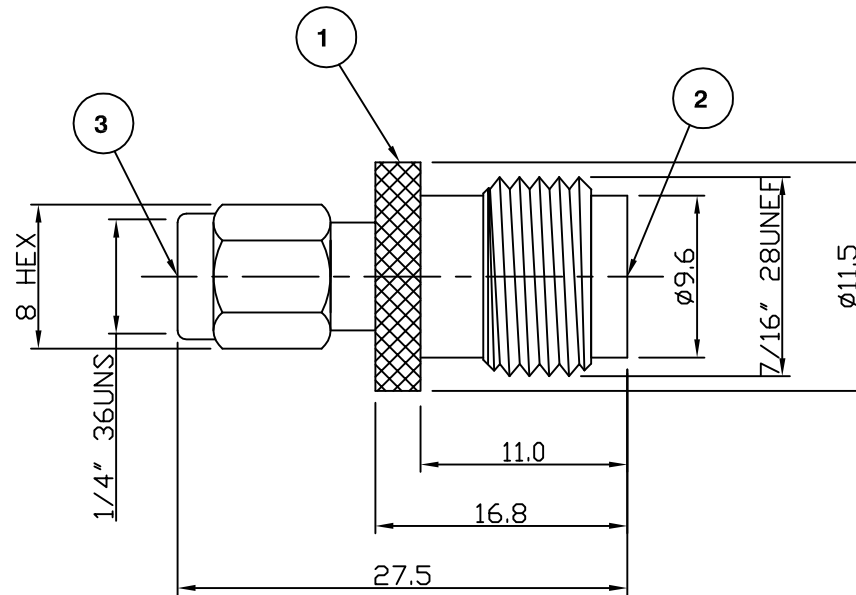

Electrical Characteristics

Nominal Impedance: 50 ohms
 Frequency Range: DC to 11 GHz
 Operating Voltage (rms): 500 V maximum at sea level
 Dielectric Withstand Voltage (rms): 1000 V maximum at sea level
 Contact Resistance: 1.5 milliohms maximum
 Insulation Resistance: 5000 megohms minimum

Mechanical Characteristics

Mating Cycles: 500 cycles minimum
 Interface Dimensions: Conform to MIL-C-39012

Environmental Characteristics

Temperature Range: -65 °C to +165 °C

	PART	DESCRIPTION
1	Body	Brass, nickel plated
2	Dielectric	PTFE
3	Contact	Brass, gold plated

Dimensional Update	JT	3	03 June 1
CAD Issue	SN	2	03 Oct 02
First Issue	PDC	1	04 Apr 01
DESCRIPTION OF REVISION	APPVD	ISS	DATE



Cinch Connectivity Solutions
 7-13 Russel Way,
 Widford Industrial Estate,
 Chelmsford, Essex,
 CM1 3AA, UK.
 Tel: +44 (0) 1245 359515
 Fax: +44 (0) 1245 358938

SCALE: Not To Scale

DIMENSIONS: mm

TOLERANCES:
 ± 0.2mm unless
 otherwise stated

DRAWN BY:

S Nash

CHECKED BY:

P Couzens

APPROVED BY:

P Couzens

DATE:

03 Oct 02

TITLE:

SMA Plug to TNC Jack

PART NUMBER:

VA508

PAGE: 1 of 1