

PART NUMBER	CABLE ASSY P/N	LENGTH
415-0561-150	415-0561-150P	150mm
415-0561-250	415-0561-250P	250mm

REV	ECO	DATE
1	INITIAL RELEASE	06/19/2024

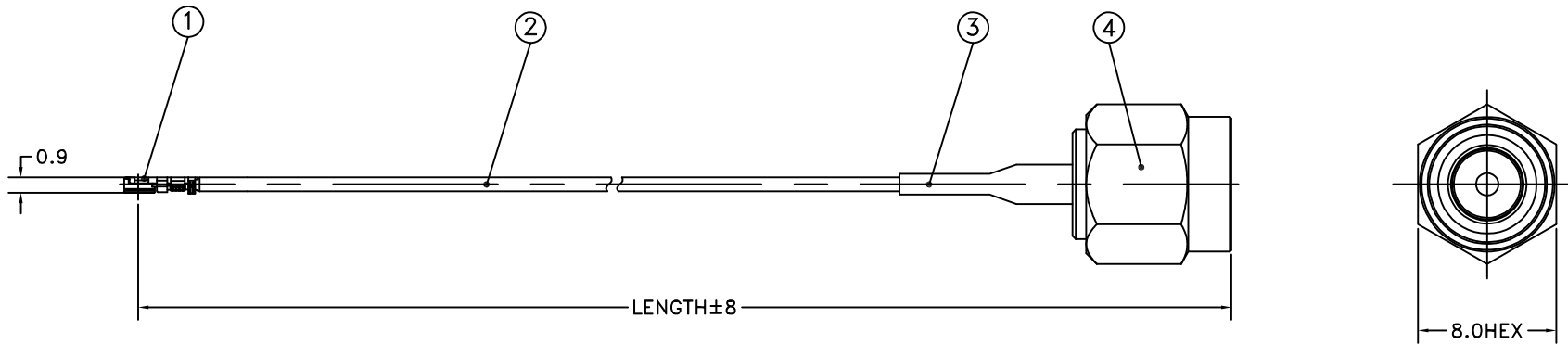

NOTE:

1. CABLE ASSEMBLY DIELECTRIC WITHSTANDING VOLTAGE: 200 VRMS.
2. REFERENCE CONNECTOR ORIENTATION AS SHOWN.
3. ASSEMBLIES 415-0561-XXXX TO BE BULK PACKED.
ASSEMBLIES 415-0561-XXX TO BE PACKAGED 5 PER BAG.

PART LIST		
ITEM	QTY	DESCRIPTION
1	1	MHF4L, GOLD PLATING
2	AR	0.81CABLE, BLACK
3	AR	HEAT SHRINK TUBE
4	1	SMA PLUG, GOLD PLATING

<p>This PROPRIETARY document is property of Cinch Connectivity Solutions. It is confidential in nature, non-transferable, and issued with the clear understanding that it is not to be traced or copied without permission and is returnable upon demand.</p> <p>INTERPRET DRAWING IN ACCORDANCE WITH ASME Y14.5-2018.</p>	Model No: 415-0561-001/999	JOHNSON		
	RoHS (EU)/2015/863 COMPLIANT	Cage Code	Title: CABLE ASSY, XMC-9 TO SMA STRAIGHT PLUG	
	UNLESS OTHERWISE SPECIFIED UNITS: MM	3RD ANGLE PROJECTION	Drawing No. 415-0561-001/999	REV. 1
	.X ±0.2 .XX ±0.08 ANGLES ±	Drawn by: TOMMY REN	Date: 06/19/2024	Size B DO NOT SCALE DRAWING
		Workmanship Std: NONE	Sheet 1 OF 1	